

Pure performance

LOWARA® 1300 SERIES - 60HZ

 **LOWARA**
a xylem brand



Available

EASY TO SELECT, CLOSE AT HAND, RIGHT PUMP FOR YOUR NEEDS

Value for money

EFFICIENT, POWERFUL

Reliable

SOLIDS HANDLING, CONTINUOUS RUNNING

Readily available pure performance pumps

Lowara® 1300 is a series of submersible pumps that deliver pure performance at outstanding value.

Combining performance and quality in a convenient, value for money package, these pumps will help ensure the smooth running and profitability of your operation. This is why Lowara is the ideal pump for sewage and surface wastewater within municipal and commercial building applications.

Moreover, Lowara makes your choice of pump easy, it only requires three straightforward steps. We have the right pump for your needs with high availability to support your business.

The Lowara 1300 series is based on technology developed and tested in tough environments the world over. That's why you can count on these pumps for trouble-free, reliable operation.

The hydraulic design of the pumps has been proven to reduce clogging and maintain efficiency. These pumps simply work and keep on working. Day in, day out, and under harsh conditions, they won't let you down - they're Lowara® 1300.

Available Value for money Reliable

With a variety of combinations of non-clog and vortex impellers to choose from, it's easy to find a pump for your needs. The impeller design gives you efficiency and solids handling capability. This helps to ensure smooth operation and delivers savings in terms of maintenance costs and energy consumption.

All pumps in the series feature a motor designed for reliable operation in submersible applications. The motors have F-class insulation or better, which allows for

continuous running without overheating, ensuring optimal cooling and long lifetime. Additionally, the pumps can handle 15 starts per hour without problem.

Typically these pumps are installed in permanent installations. However, some models have the option of a free-standing installation so that the pump can be easily moved from one site to another. See methods of installation (page 7) for further reference.

Application areas

Municipal:

- Domestic sewage pumping stations
- Wastewater pumping stations
- Retention basins
- Storm water pumping stations

Commercial building:

- Drainage water
- Domestic sewage pumping stations
- Ground water

Tough to beat

Robust

All components are made from robust materials for easy maintenance and long life.

Powerful

Motor is specifically designed for reliable operation in submersible applications. It can run continuously without overheating - a true workhorse.

Durable

Heavy-duty bearings with long life provide peace of mind.

Environmentally friendly

Cooling system is designed to use the surrounding media to cool the pump; no use of environmentally hazardous fluids such as oils.

Safe and straightforward

Cable entry prevents both cable strain and leakage.

Smooth

The double mechanical seal provides extra reliability and protects against leakage.

Flexible

Drilled pump housing, ready for any installation method.

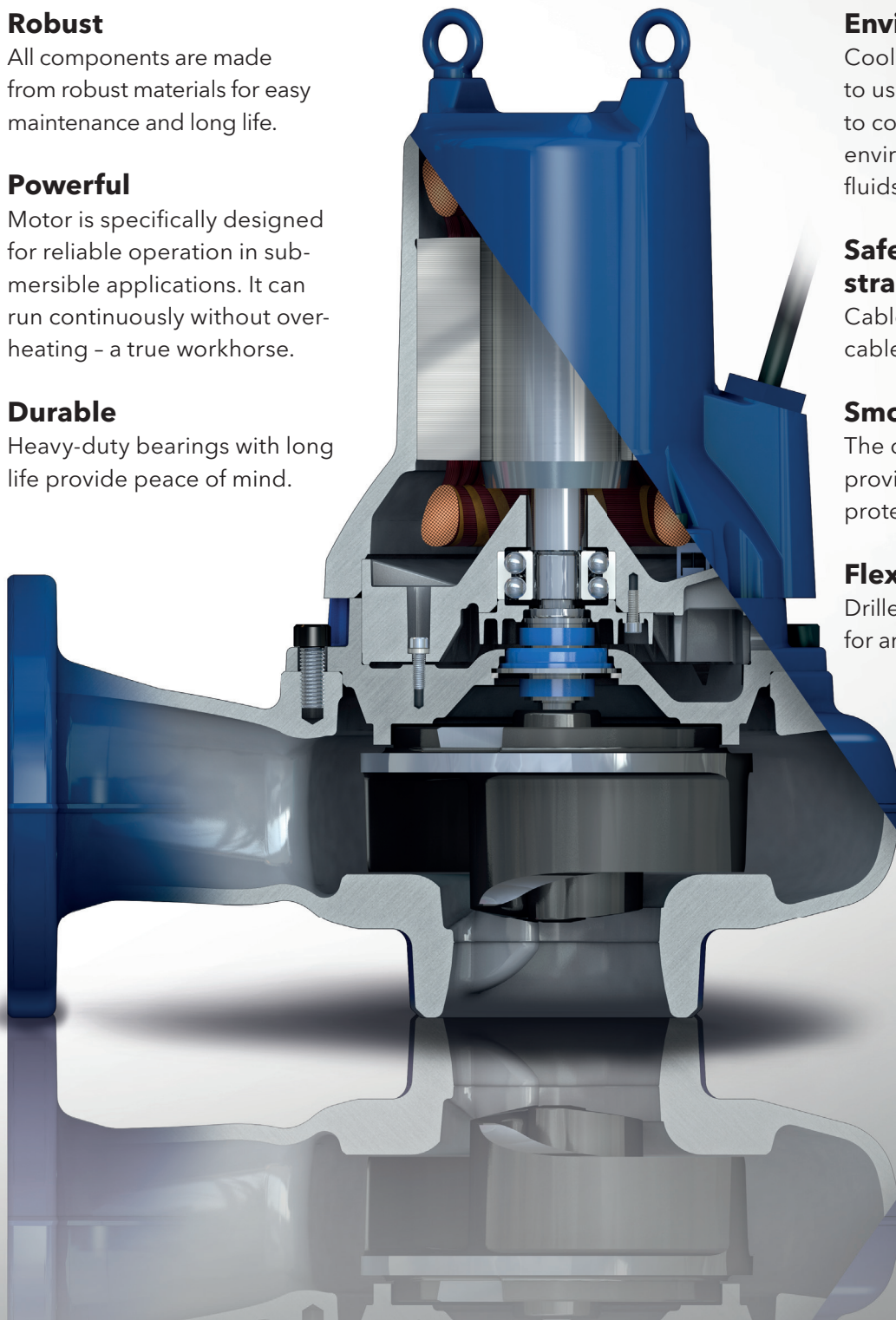

Installation methods and accessory kits

The Lowara® 1300 series is designed to fit your needs. You start with a bare pump and order the right kit depending on your desired installation method.

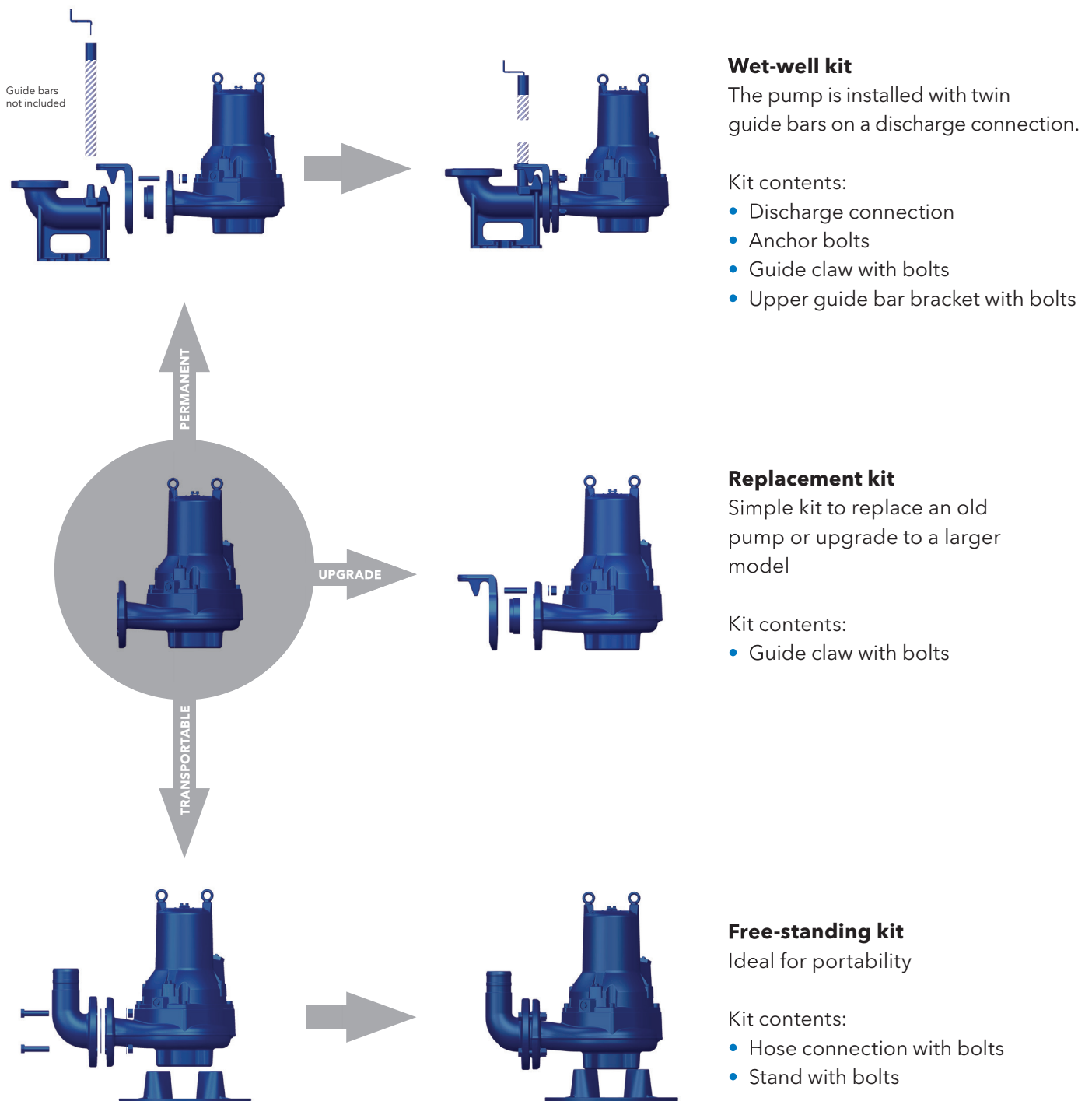

Selecting & ordering

Configure your product order and generate order number

We've made it easy for you to select and configure your pump with appropriate accessories; it's done in just three simple steps and you build your order number as you go.

1

Select the pump model ideal for your needs from the product pages that follow.

2

For every model and choice of outlet dimension there is a partially filled order number. Configure your pump from the relevant selection tables and you will automatically get the information to build and complete your order number as you go!

Model Model variant Outlet dimension (nominal, mm) Pole Frequency (5=50, 6=60) Phase

1315S-80X.253.---.---/-

Selected model A B C D



Lowara® 1315 Non-clog

Pump Data	
Model	1315S
Impeller Type	Non-clog
Outlet size (mm)	80
Weight (kg)	95
Poles	2
Insulation Class	F
Starts per hour	15
Cable	4G1.5 + 2x1.5

Motor Data 400V	
Phase	3
Rated Power	3.3
Rated current	6.5
Rated Power (hp)	0.86
Starting current	49
Connection	D

Material Data	
Impeller	grey cast iron
Pump housing	grey cast iron
Stator housing	grey cast iron
Shaft	stainless steel
Inner mechanical seal	carbon/aluminum oxide
Outer mechanical seal	cermeted carbide/aluminum oxide
O-rings	nitrile
Cable sheathing	nitrile

Process Data	
Max submergence	20 m
Max fluid temp	40°C*
pH range of pumped liquid	5.5 - 14

Power Cable Data	
Cable type (mm ²)	4G1.5 + 2x1.5
Outer Diameter (mm)	16
Weight (kg/m)	0.32

Performance curves



Selection table

Model	DN	Installation*	Pole	Frequency	Order no.	Voltage	Cable	Order num.
1315S	65	X	2	F	1315S-65X	400	10	1315S-65X
1315S	80	X	2	F	1315S-80X	400	10	1315S-80X
1315M	100	X	4	F	1315M-100X	400	10	1315M-100X

*X= Bare pump.

Pump dimensions (mm)



	1315S	1315M
A	508	524
B	377	464
C	147	179
D	230	285
E	147	161
F	148	194
G	90	109

Installation kit selection table*

DN	Free-standing	Wat well	Replacement
65	1315-65H (hose) 1315-65T (threaded)	1315-65W	1315-65R
80	1315-80H (hose) 1315-80T (threaded)	1315-80W	1315-80R
100	1315-100H (hose) 1315-100T (threaded)	1315-100W	1315-100R

3

Select your accessory kit from the relevant accessory selection tables, i.e. installation kit. Please make sure that your configuration corresponds to the right order number and accessory kits and you are ready to order.

Lowara® 1305 Non-clog



Performance curves

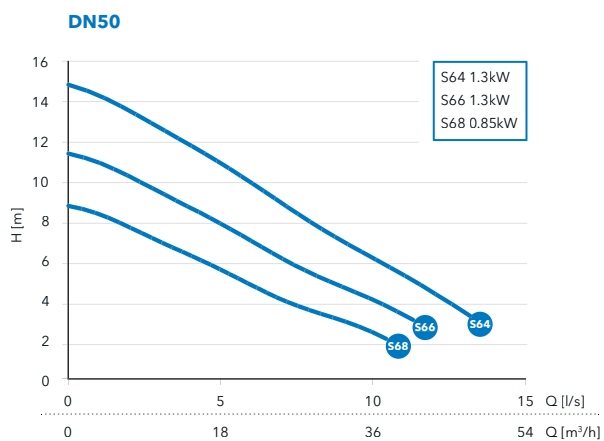

Selection table

Model	DN	Installation*	Pole	Freq (Hz)	Phase	Rated Power	Curve no	Voltage	Cable	Order number**
1305S	50	W, T	2	60	1, 3	[see chart]	S64, S66, S68	230, 380	10	1305S-50-.26-...-.../10

*W=Wet well only, T=Free-standing threaded outlet only.

** For information on configuring the right order number, see page 7. Pumps come standard with thermal switches.

Pump Data

Model	1305S
Impeller Type	Non-clog
Outlet size (mm)	50
Weight (kg)	30
Pole	2
Insulation Class	F
Starts per hour	15
Cable	4G1.5 + 2x1.5

Motor Data

	1305S		
Voltage	380	380	230
Phase	3	3	1
Rated Power (kW)	1.3	0.85	0.85
Rated current (A)	2.5	1.9	4.9
Full Load Power Factor	0.83	0.71	0.99
Starting current (A)	19	19	17
Connection	Y	Y	-

Material Data

Impeller	grey cast iron
Pump housing	grey cast iron
Stator housing	grey cast iron
Shaft	stainless steel
Inner mechanical seal	carbon/aluminum oxide
Outer mechanical seal	cemented carbide/aluminum oxide
O-rings	nitrile
Cable sheathing	nitrile

Process Data

Max submergence	20 m
Max fluid temp	40 °C
pH range of pumped liquid	5.5 - 14

Power Cable Data

Cable type (mm ²)	4G1.5 + 2x1.5
Outer Diameter (mm)	16
Weight (kg/m)	0.32

Pump dimensions (mm)

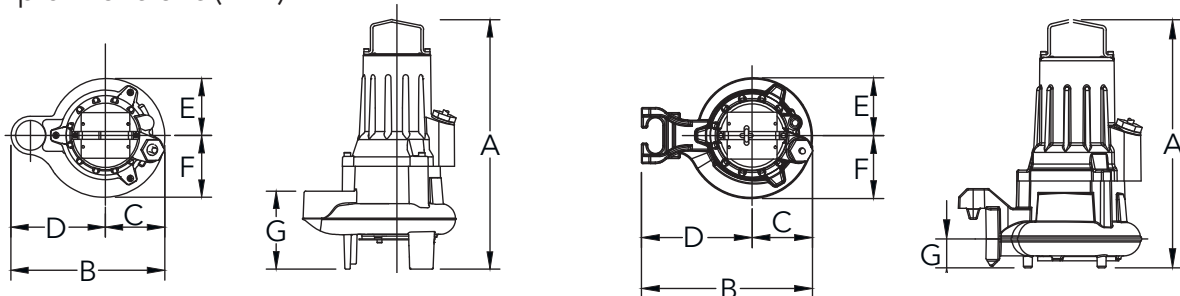

	Free-standing 1305S
A	418
B	298
C	116
D	182
E	97
F	119
G	121

	Wet well 1305S
A	397
B	272
C	116
D	156
E	97
F	120
G	44

Installation kit selection table*

DN	Free-standing	Wet well	Replacement
50	included	1305-50W	included

* For more information, see page 6.

Lowara® 1305 Vortex



Performance curves

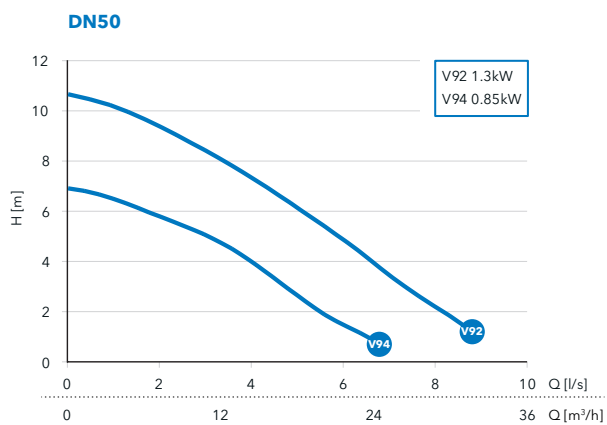

Selection table

Model	DN	Installation*	Pole	Freq (Hz)	Phase	Rated Power	Curve no	Voltage	Cable	Order number**
1305H	50	W, T	2	60	1, 3	[see chart]	V92, V94	230, 380	10	1305H-50-.26-...../10

*W=Wet well only, T=Free-standing threaded outlet only.

** For information on configuring the right order number, see page 7. Pumps come standard with thermal switches.

Pump Data

Model	1305H
Impeller Type	Vortex
Outlet size (mm)	50
Weight (kg)	30
Pole	2
Insulation Class	F
Starts per hour	15
Cable	4G1.5 + 2x1.5

Motor Data

	1305H		
Voltage	380	380	230
Phase	3	3	1
Rated Power (kW)	1.3	0.85	0.85
Rated current (A)	2.5	1.9	4.9
Full Load Power Factor	0.83	0.71	0.99
Starting current (A)	19	19	17
Connection	Y	Y	-

Material Data

Impeller	grey cast iron
Pump housing	grey cast iron
Stator housing	grey cast iron
Shaft	stainless steel
Inner mechanical seal	carbon/aluminum oxide
Outer mechanical seal	cemented carbide/aluminum oxide
O-rings	nitrile
Cable sheathing	nitrile

Process Data

Max submergence	20 m
Max fluid temp	40 °C
pH range of pumped liquid	5.5 - 14

Power Cable Data

Cable type (mm ²)	4G1.5 + 2x1.5 4G2.5 + 2x1.5*
Outer Diameter (mm)	16 18
Weight (kg/m)	0.32 0.43

Pump dimensions (mm)

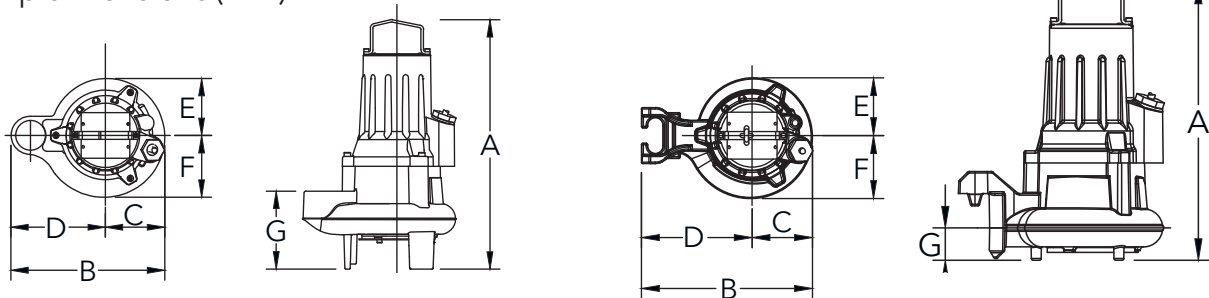

	Free-standing 1305H
A	465
B	299
C	116
D	183
E	103
F	114
G	140

	Wet well 1305H
A	423
B	272
C	116
D	156
E	104
F	114
G	50

Installation kit selection table*

DN	Free-standing	Wet well	Replacement
50	included	1305-50W	included

* For more information, see page 6.

Lowara® 1310 Non-clog



Performance curves

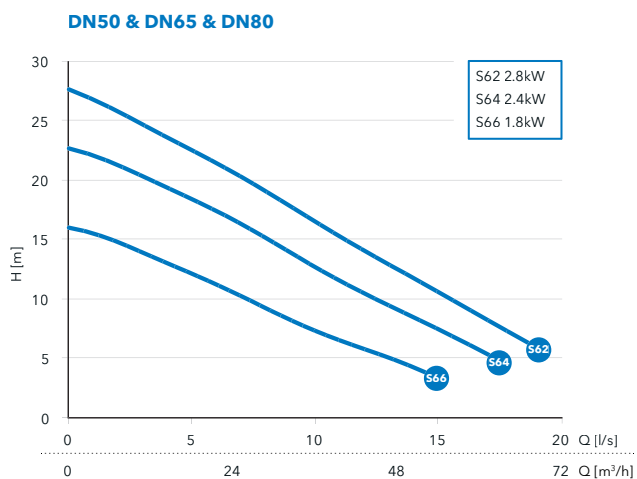

Selection table

Model	DN	Installation*	Pole	Freq (Hz)	Phase	Rated Power	Curve no	Voltage	Cable	Order number**
1310S	50	W, T	2	60	1, 3	[see chart]	S62, S64, S66	230, 220/380/440	10	1310S-50-.26-...../10
1310S	65	X	2	60	1, 3	[see chart]	S62, S64, S66	230, 220/380/440	10	1310S-65X.26-...../10
1310S	80	X	2	60	1, 3	[see chart]	S62, S64, S66	230, 220/380/440	10	1310S-80X.26-...../10

*W=Wet well only, T=Free-standing threaded outlet only.

** For information on configuring the right order number, see page 7. Pumps come standard with thermal switches.

Pump Data

Model	1310S
Impeller Type	Non-clog
Outlet size (mm)	50 65 80
Weight (kg)	46
Pole	2
Insulation Class	F
Starts per hour	15
Cable	4G1.5 + 2x1.5 4G2.5 + 2x1.5*

*1phase

Motor Data

1310S						
Voltage	220 380 440	220 380 440	220 380 440	230	230	230
Phase	3	3	3	1	1	1
Rated Power (kW)	2.8	2.4	1.8	2.8	2.4	1.8
Rated current (A)	10.1 5.9 5.0	8.7 5.0 4.3	6.7 4.1 3.3	19.2	14.3	9.9
Full Load Power Factor	0.90 0.87 0.91	0.89 0.84 0.89	0.84 0.78 0.85	0.94	0.96	0.97
Starting current (A)	59 37 29	59 37 29	59 37 29	37	37	37
Connection	D// Y// Dser	D// Y// Dser	D// Y// Dser	-	-	-

Material Data

Impeller	grey cast iron
Pump housing	grey cast iron
Stator housing	grey cast iron
Shaft	stainless steel
Inner mechanical seal	carbon/aluminum oxide
Outer mechanical seal	cemented carbide/aluminum oxide
O-rings	nitrile
Cable sheathing	nitrile

Process Data

Max submergence	20 m
Max fluid temp	40 °C
pH range of pumped liquid	5.5 - 14

Power Cable Data

Cable type (mm ²)	4G1.5 + 2x1.5 4G2.5 + 2x1.5
Outer Diameter (mm)	16 18
Weight (kg/m)	0.32 0.43

Pump dimensions (mm)

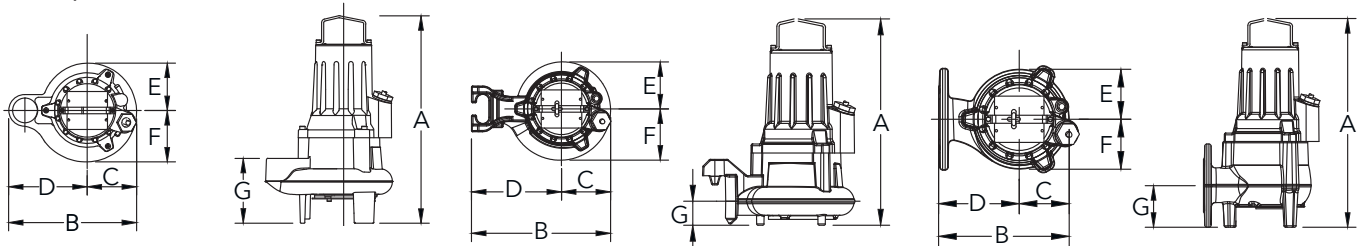

Free-standing 1310S	
A	433
B	304
C	112
D	192
E	103
F	123
G	121

Wet well 1310S	
A	422
B	287
C	112
D	175
E	103
F	123
G	45

X-installation 1310S	
A	457
B	318
C	118
D	200
E	103
F	123
G	100

Installation kit selection table*

DN	Free-standing	Wet well	Replacement
50	included	1310-50W	included
65	1310-65H (hose), 1310-65T (threaded)	1310-65W	1310-65R
80	1310-80H (hose), 1310-80T (threaded)	1310-80W	1310-80R

* For more information, see page 6.

Lowara® 1310 Vortex



Performance curves

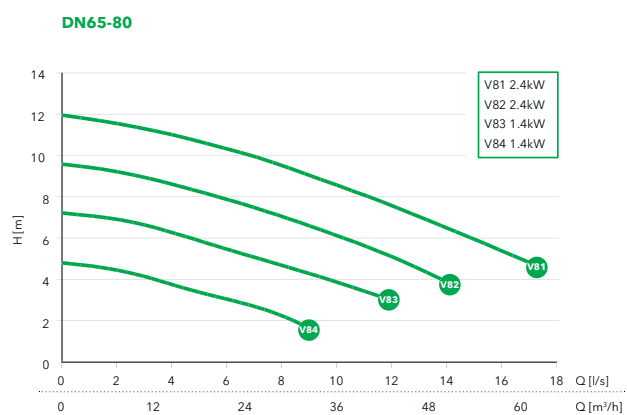
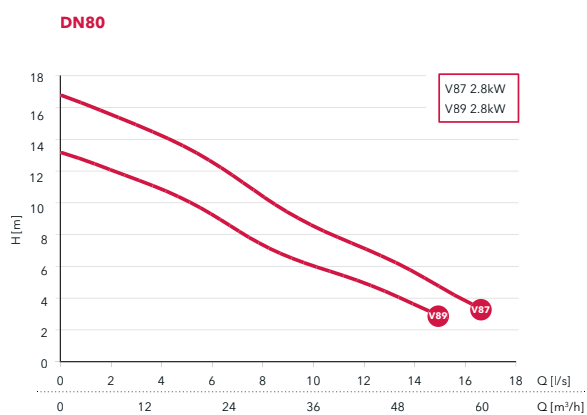
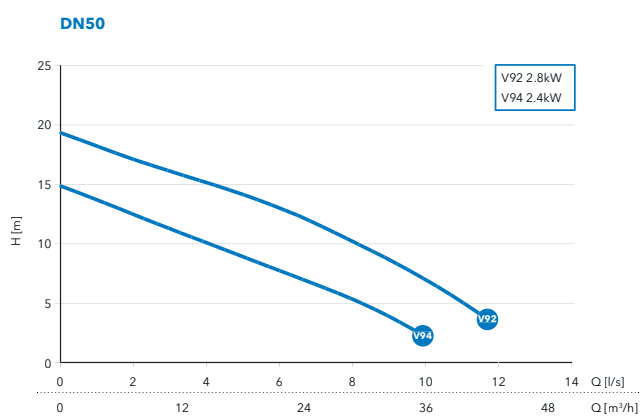

Selection table

Model	DN	Installation*	Pole	Freq (Hz)	Phase	Rated Power	Curve no	Voltage	Cable	Order number**
1310H	50	W, T	2	60	1, 3	[see chart]	V92, V94	230, 220/380/440	10	1310H-50-.26-....-/10
1310M	80	X	2	60	1, 3	[see chart]	V87, V89	230, 220/380/440	10	1310M-80X-.26-....-/10
1310L	65	X	4	60	1, 3	[see chart]	V81, V82, V83, V84	230, 380	10	1310L-65X-.46-....-/10

*W=Wet well only, T=Free-standing threaded outlet only, X=Bare pump.

** For information on configuring the right order number, see page 7. Pumps come standard with thermal switches.

Pump Data

Model	1310H/M	1310L
Impeller Type	Vortex	Vortex
Outlet size (mm)	50 80	65-80
Weight (kg)	46	46
Pole	2	4
Insulation Class	F	F
Starts per hour	15	15
Cable	4G1.5 + 2x1.5 4G2.5 + 2x1.5*	4G1.5 + 2x1.5

*1phase

Motor Data

	1310H				1310M		1310L			
	220 380 440	220 380 440	230	230	220 380 440	230	380	380	230	230
Voltage	220 380 440	220 380 440	230	230	220 380 440	230	380	380	230	230
Phase	3	3	1	1	3	1	3	3	1	1
Rated Power (kW)	2.8	2.4	2.8	2.4	2.8	2.8	2.4	1.4	1.5	1.2
Rated current (A)	10.1 5.9 5.0	8.7 5.0 4.3	19.2	14.3	10.1 5.9 5.0	19.2	5.7	3.9	9.4	7.7
Full Load Power Factor	0.90 0.87 0.91	0.89 0.84 0.89	0.94	0.96	0.90 0.87 0.91	0.94	0.85	0.71	0.99	0.99
Starting current (A)	59 37 29	59 37 29	37	37	59 37 29	37	27	27	37	37
Connection	D// Y// Dser	D// Y// Dser	-	-	D// Y// Dser	-	Y	Y	-	-

Material Data

Impeller	grey cast iron
Pump housing	grey cast iron
Stator housing	grey cast iron
Shaft	stainless steel
Inner mechanical seal	carbon/aluminum oxide
Outer mechanical seal	cemented carbide/aluminum oxide
O-rings	nitrile
Cable sheathing	nitrile

Process Data

Max submergence	20 m
Max fluid temp	40 °C
pH range of pumped liquid	5.5 - 14

Power Cable Data

Cable type (mm ²)	4G1.5 + 2x1.5 4G2.5 + 2x1.5*
Outer Diameter (mm)	16 18
Weight (kg/m)	0.32 0.43

Pump dimensions (mm)

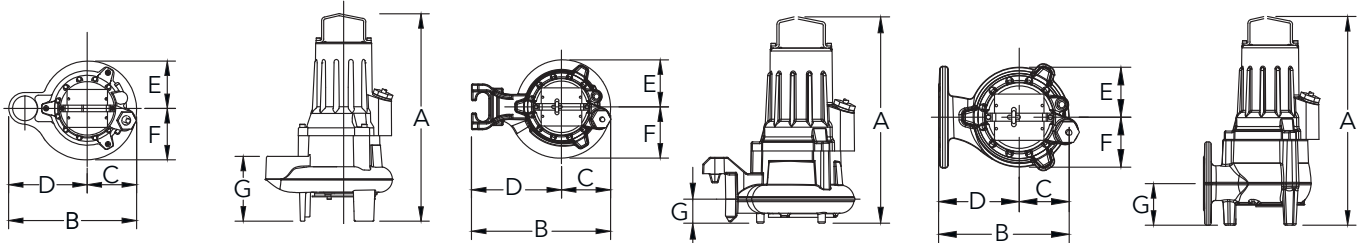

	Free-standing		Wet well		X-installation	
	1310H		1310H		1310M	1310L
A	503		455		535	464
B	310		285		259	346
C	120		119		99	146
D	190		166		160	200
E	115		114		106	146
F	125		124		106	146
G	165		53		100	85

Installation kit selection table*

DN	Free-standing	Wet well	Replacement
50	included	1310-50W	included
65	1310-65H (hose), 310-65T (threaded)	1310-65W	1310-65R
80	1310-80H (hose), 1310-80T (threaded)	1310-80W	1310-80R

*For more information, see page 6.

Lowara® 1315 Non-clog



Performance curves

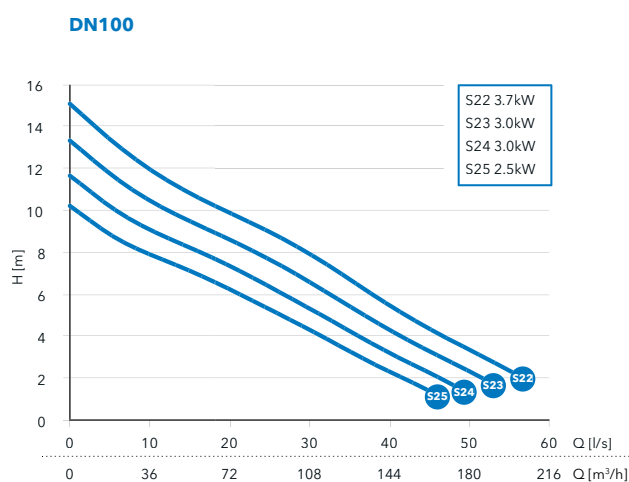
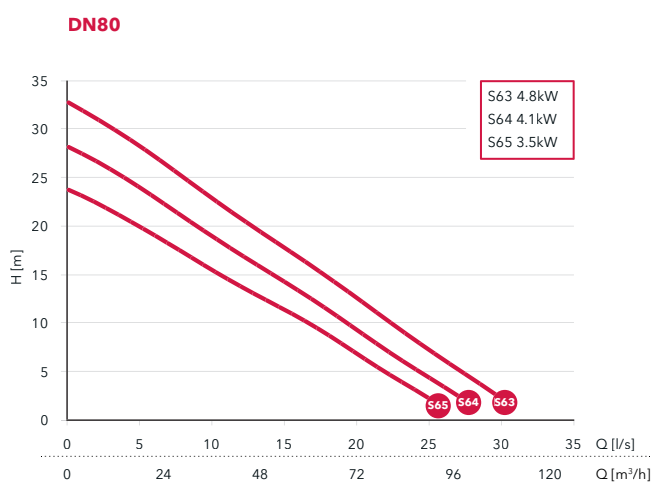

Selection table

Model	DN	Installation*	Pole	Freq (Hz)	Phase	Rated Power	Curve no	Voltage	Cable	Order number**
1315S	80	X	2	60	1, 3	[see chart]	S63, S64, S65	230, 220/380/440	10	1315S-80X.26-...-.../10
1315M	100	X	4	60	1, 3	[see chart]	S22, S23, S24, S25	230, 220/380/440	10	1315M-100X.46-...-.../10

* X=Bare pump.

** For information on configuring the right order number, see page 7. Pumps come standard with thermal switches.

Pump Data

Model	1315S	1315M
Impeller Type	Non-clog	Non-clog
Outlet size (mm)	80	100
Weight (kg)	95	95
Pole	2	4
Insulation Class	F	F
Starts per hour	15	15
Cable	4G2.5 + 2x1.5	4G1.5 + 2x1.5 4G2.5 + 2x1.5*

*1phase

Motor Data

	1315S					1315M				
	220 380 440	220 380 440	220 380 440	230	230	220 380 440	220 380 440	220 380 440	230	230
Voltage	220 380 440	220 380 440	220 380 440	230	230	220 380 440	220 380 440	220 380 440	230	230
Phase	3	3	3	1	1	3	3	3	1	1
Rated Power (kW)	4.8	4.1	3.5	4.1	3.5	3.7	3	2.5	3	2.5
Rated current (A)	17 10 8.7	15 8.8 7.6	14 7.8 6.8	22	18.5	14 8.1 7	11 6.6 5.7	9.8 5.7 5	17.1	14.3
Full Load Power Factor	0.86 0.86 0.86	0.83 0.83 0.83	0.79 0.79 0.79	1	1	0.87 0.87 0.87	0.84 0.84 0.84	0.80 0.80 0.80	0.98	0.98
Starting current (A)	126 72 63	126 72 63	126 72 63	96	96	67 36 34	67 36 34	67 36 34	77	77
Connection	D// Y// Dser	D// Y// Dser	D// Y// Dser	-	-	D// Y// Dser	D// Y// Dser	D// Y// Dser	-	-

Material Data

Impeller	grey cast iron
Pump housing	grey cast iron
Stator housing	grey cast iron
Shaft	stainless steel
Inner mechanical seal	carbon/aluminum oxide
Outer mechanical seal	cemented carbide/aluminum oxide
O-rings	nitrile
Cable sheathing	nitrile

Process Data

Max submergence	20 m
Max fluid temp	40 °C
pH range of pumped liquid	5.5 - 14

Power Cable Data

Cable type (mm ²)	4G1.5 + 2x1.5 4G2.5 + 2x1.5
Outer Diameter (mm)	16 18
Weight (kg/m)	0.32 0.43

Pump dimensions (mm)

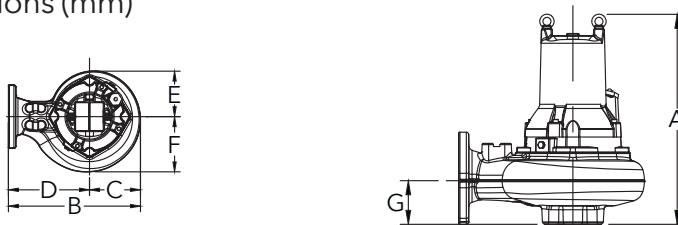

	1315S	1315M
A	508	524
B	377	464
C	147	179
D	230	285
E	146	161
F	148	194
G	90	109

Installation kit selection table*

DN	Free-standing	Wet well	Replacement
65	1315-65H (hose), 1315-65T (threaded)	1315-65W	1315-65R
80	1315-80H (hose), 1315-80T (threaded)	1315-80W	1315-80R
100	1315-100H (hose), 1315-100T (threaded)	1315-100W	1315-100R

* For more information, see page 6.

Lowara® 1315 Vortex



Performance curves

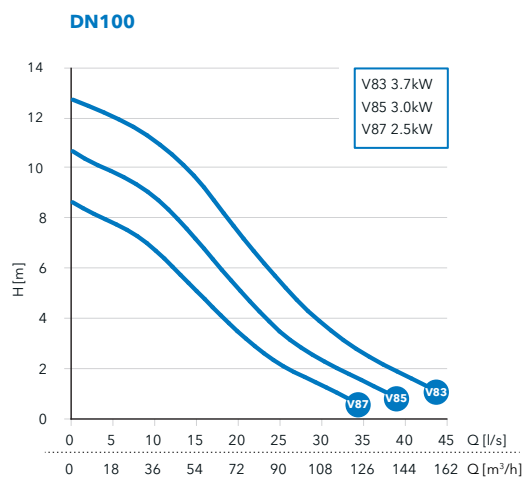
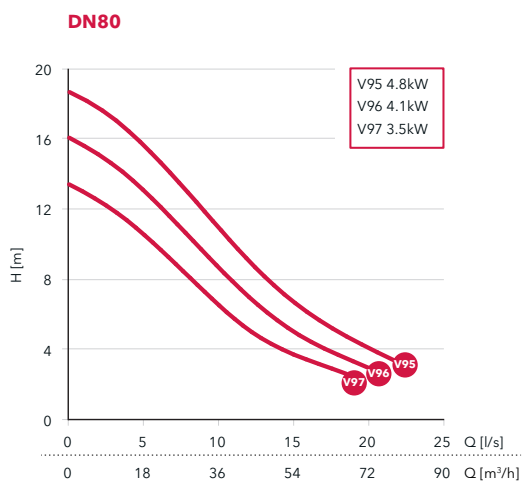

Selection table

Model	DN	Installation*	Pole	Freq (Hz)	Phase	Rated Power	Curve no	Voltage	Cable	Order number**
1315H	80	X	2	60	1, 3	[see chart]	V95, V96, V97	230, 220/380/440	10	1315H-80X-.26-....-/10
1315M	100	X	4	60	1, 3	[see chart]	V83, V85, V87	230, 220/380/440	10	1315M-100X-.46-....-/10

* X=Bare pump.

** For information on configuring the right order number, see page 7. Pumps come standard with thermal switches.

Pump Data

Model	1315H	1315M
Impeller Type	Vortex	Vortex
Outlet size (mm)	80	100
Weight (kg)	95	95
Pole	2	4
Insulation Class	F	F
Starts per hour	15	15
Cable	4G2.5 + 2x1.5	4G1.5 + 2x1.5 4G2.5 + 2x1.5*

*1phase

Motor Data

	1315H					1315M					
	220	380	440	220	380	440	220	380	440	230	230
Voltage	220	380	440	220	380	440	220	380	440	230	230
Phase	3	3	3	3	3	3	3	3	3	1	1
Rated Power (kW)	4.8	4.1	3.5	4.1	3.5	3.5	3.7	3	2.5	3	2.5
Rated current (A)	17 10 8.7	15 8.8 7.6	14 7.8 6.8	22	18.5	18.5	14 8.1 7	11 6.6 5.7	9.8 5.7 5	17.1	14.3
Full Load Power Factor	0.86 0.86 0.86	0.83 0.83 0.83	0.79 0.79 0.79	1	1	1	0.87 0.87 0.87	0.84 0.84 0.84	0.80 0.80 0.80	0.98	0.98
Starting current (A)	126 72 63	126 72 63	126 72 63	96	96	96	67 36 34	67 36 34	67 36 34	77	77
Connection	D// Y// Dser	D// Y// Dser	D// Y// Dser	-	-	-	D// Y// Dser	D// Y// Dser	D// Y// Dser	-	-

Material Data

Impeller	grey cast iron
Pump housing	grey cast iron
Stator housing	grey cast iron
Shaft	stainless steel
Inner mechanical seal	carbon/aluminum oxide
Outer mechanical seal	cemented carbide/aluminum oxide
O-rings	nitrile
Cable sheathing	nitrile

Process Data

Max submergence	20 m
Max fluid temp	40 °C
pH range of pumped liquid	5.5 - 14

Power Cable Data

Cable type (mm ²)	4G1.5 + 2x1.5 4G2.5 + 2x1.5
Outer Diameter (mm)	16 18
Weight (kg/m)	0.32 0.43

Pump dimensions (mm)

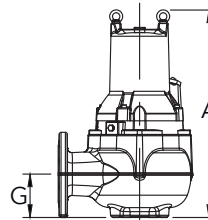
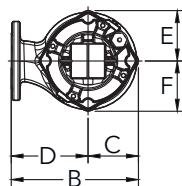

	1315H	1315M
A	523	573
B	342	367
C	142	142
D	200	225
E	144	148
F	145	147
G	100	120

Installation kit selection table*

DN	Free-standing	Wet well	Replacement
65	1315-65H (hose), 1315-65T (threaded)	1315-65W	1315-65R
80	1315-80H (hose), 1315-80T (threaded)	1315-80W	1315-80R
100	1315-100H (hose), 1315-100T (threaded)	1315-100W	1315-100R

*For more information, see page 6.

Lowara® 1320 Non-clog



Performance curves

DN80

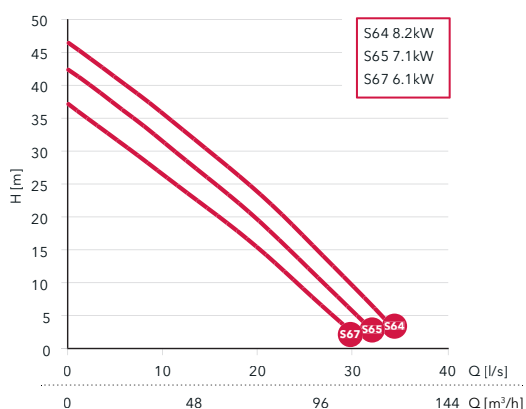

DN100

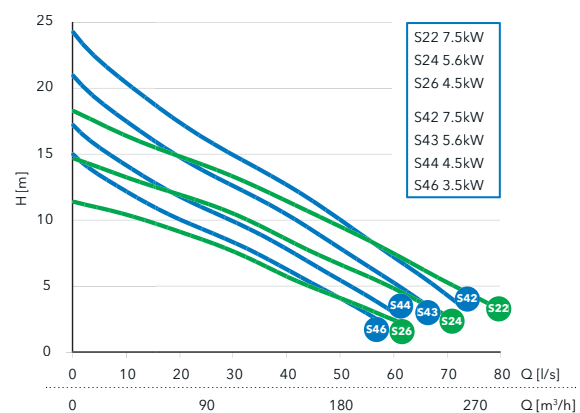

Selection table

Model	DN	Installation*	Pole	Freq (Hz)	Phase	Rated Power	Curve no	Voltage	Cable	Order number**
1320S	80	X	2	60	1, 3	[see chart]	S64, S65, S67	230, 220/380/440	10	1320S-80X.26-....-/10
1320H	100	X	4	60	1, 3	[see chart]	S42, S43, S44, S46	230, 220/380/440	10	1320H-100X.46-....-/10
1320M	100	X	4	60	1, 3	[see chart]	S22, S24, S26	230, 220/380/440	10	1320M-100X.46-....-/10

* X=Bare pump.

** For information on configuring the right order number, see page 7. Pumps come standard with thermal switches.

Pump Data

Model	1320S	1320H	1320M
Impeller Type	Non-clog	Non-clog	Non-clog
Outlet size (mm)	80	100	100
Weight (kg)	130	140	156
Pole	2	4	4
Insulation Class	F	F	F
Starts per hour	15	15	15
Cable	4G4 + 2x1.5 4G10 + S(2x0.5)*	4G4 + 2x1.5 4G6 + 2x1.5*	4G4 + 2x1.5 4G6 + 2x1.5*

*1phase

Motor Data

1320S							
Voltage	220 380 440	220 380 440	220 380 440	230	230	230	
Phase	3	3	3	1	1	1	
Rated Power (kW)	8.2	7.1	6.1	7.1	6.1	5.6	
Rated current (A)	27 15 13	24 14 12	21 12 10	42	37	34	
Full Load Power Factor	0.9 0.91 0.9	0.88 0.89 0.89	0.86 0.87 0.87	0.87	0.85	0.84	
Starting current (A)	222 128 111	222 128 111	222 128 111	138	138	138	
Connection	D// Y// Dser	D// Y// Dser	D// Y// Dser	-	-	-	
1320H/M							
Voltage	220 380 440	220 380 440	220 380 440	220 380 440	230	230	230
Phase	3	3	3	3	1	1	1
Rated Power (kW)	7.5	5.6	4.5	3.5	5.6	4.5	3.5
Rated current (A)	27 16 14	20 12 10	17 9.7 8.4	14 8.1 7.1	35	29	24
Full Load Power Factor	0.86 0.87 0.86	0.84 0.84 0.84	0.8 0.81 0.8	0.75 0.75 0.75	0.85	0.83	0.79
Starting current (A)	121 70 61	121 70 61	121 70 61	121 70 61	107	107	107
Connection	D// Y// Dser	D// Y// Dser	D// Y// Dser	D// Y// Dser	-	-	-

Material Data

Impeller	grey cast iron
Pump housing	grey cast iron
Stator housing	grey cast iron
Shaft	stainless steel
Inner mechanical seal	carbon/cemented carbide
Outer mechanical seal	cemented carbide/cemented carbide
O-rings	nitrile
Cable sheathing	nitrile

Process Data

Max submergence	20 m
Max fluid temp	40 °C
pH range of pumped liquid	5.5 - 14

Power Cable Data

Cable type (mm ²)	4G4 + 2x1.5 4G6 + 2x1.5 4G10 + S(2x0.5)
Outer Diameter (mm)	22 26 26
Weight (kg/m)	0.63 0.83 0.85

Pump dimensions (mm)

	1320S	1320H	1320M
A	570	592	618
B	425	523	523
C	165	213	213
D	260	310	310
E	151	194	180
F	172	232	214
G	90	117	124

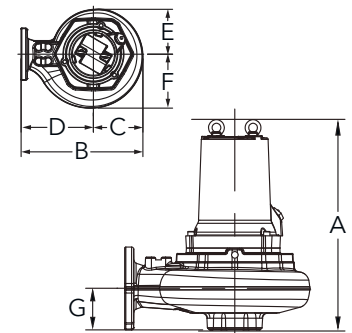

Installation kit selection table*

DN	Free-standing	Wet well	Replacement
80	1320-80H (hose), 1320-80T (threaded)	1320-80W	1320-80R
100	1320-100H (hose), 1320-100T (threaded)	1320-100W	1320-100R

* For more information, see page 6.

Lowara® 1320 Vortex



Performance curves

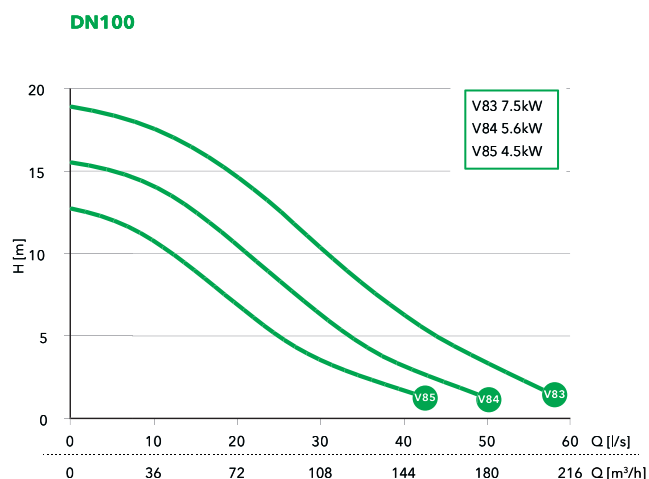
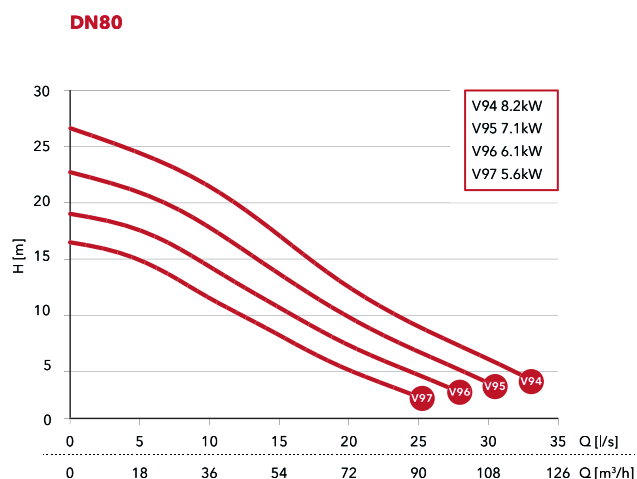

Selection table

Model	DN	Installation*	Pole	Freq (Hz)	Phase	Rated Power	Curve no	Voltage	Cable	Order number**
1320H	80	X	2	60	1, 3	[see chart]	V94, V95, V96, V97	230, 220/380/440	10	1320H-80X-.26-...../10
1320M	100	X	4	60	1, 3	[see chart]	V83, V84, V85	230, 220/380/440	10	1320M-100X-.46-...../10

* X=Bare pump.

** For information on configuring the right order number, see page 7. Pumps come standard with thermal switches.

Pump Data

Model	1320H	1320M
Impeller Type	Vortex	Vortex
Outlet size (mm)	80	100
Weight (kg)	140	156
Pole	2	4
Insulation Class	F	F
Starts per hour	15	15
Cable	4G4 + 2x1.5 4G10 + S(2x0.5)*	4G4+ 2x1.5 4G6 + 2x1.5*

*1phase

Motor Data

1320H							
Voltage	220 380 440	220 380 440	220 380 440	220 380 440	230	230	230
Phase	3	3	3	3	1	1	1
Rated Power (kW)	8.2	7.1	6.1	5.6	7.1	6.1	5.6
Rated current (A)	27 15 13	24 14 12	21 12 10	20 12 10	42	37	34
Full Load Power Factor	0.9 0.91 0.9	0.88 0.89 0.89	0.86 0.87 0.87	0.84 0.84 0.84	0.87	0.85	0.84
Starting current (A)	222 128 111	222 128 111	222 128 111	121 70 61	138	138	138
Connection	D// Y// Dser	D// Y// Dser	D// Y// Dser	D// Y// Dser	-	-	-
1320M							
Voltage	220 380 440	220 380 440	220 380 440	230	230	230	230
Phase	3	3	3	1	1	1	1
Rated Power (kW)	7.5	5.6	4.5	5.6	4.5	3.5	3.5
Rated current (A)	27 16 14	20 12 10	17 9.7 8.4	35	29	24	24
Full Load Power Factor	0.86 0.87 0.86	0.84 0.84 0.84	0.8 0.81 0.8	0.85	0.83	0.79	0.79
Starting current (A)	121 70 61	121 70 61	121 70 61	107	107	107	107
Connection	D// Y// Dser	D// Y// Dser	D// Y// Dser	-	-	-	-

Material Data

Impeller	grey cast iron
Pump housing	grey cast iron
Stator housing	grey cast iron
Shaft	stainless steel
Inner mechanical seal	carbon/cemented carbide
Outer mechanical seal	cemented carbide/cemented carbide
O-rings	nitrile
Cable sheathing	nitrile

Process Data

Max submergence	20 m
Max fluid temp	40 °C
pH range of pumped liquid	5.5 - 14

Power Cable Data

Cable type (mm ²)	4G4 + 2x1.5 4G6 + 2x1.5 4G10 + S(2x0.5)
Outer Diameter (mm)	22 26 26
Weight (kg/m)	0.63 0.83 0.85

Pump dimensions (mm)

	1320H	1320M
A	610	674
B	375	419
C	165	174
D	210	245
E	154	166
F	154	167
G	100	123

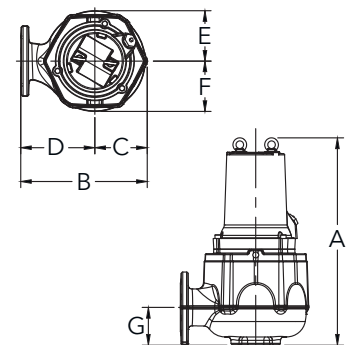

Installation kit selection table*

DN	Free-standing	Wet well	Replacement
80	1320-80H (hose), 1320-80T (threaded)	1320-80W	1320-80R
100	1320-100H (hose), 1320-100T (threaded)	1320-100W	1320-100R

*For more information, see page 6.

Lowara® 1325 Non-clog



Performance curves

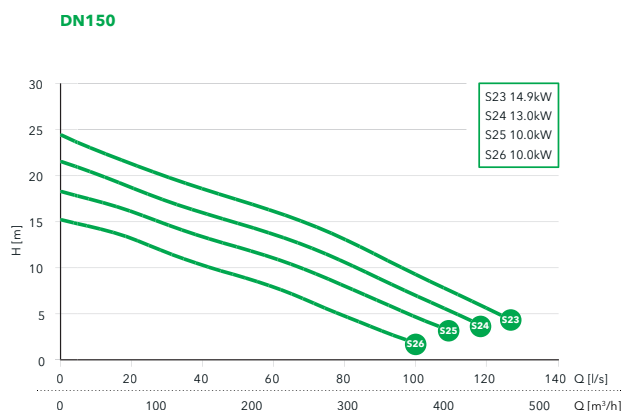
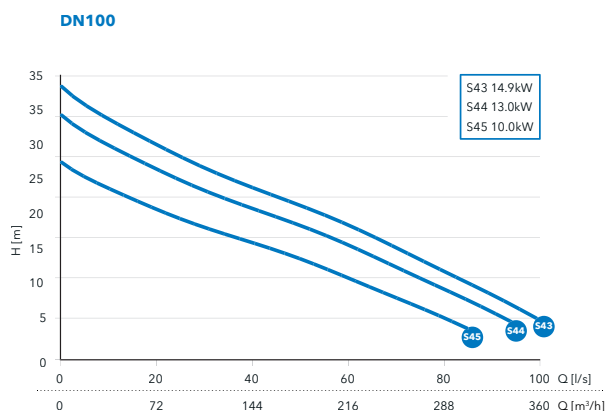
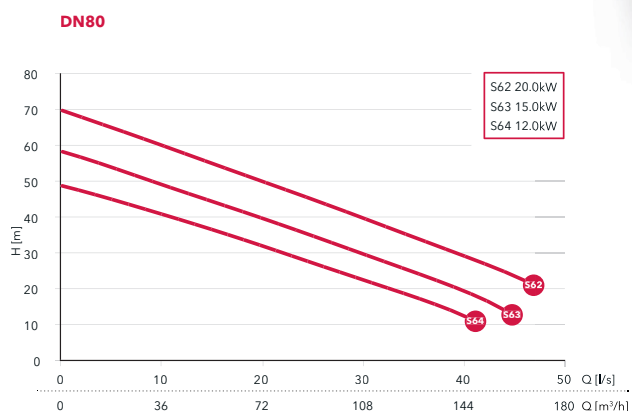

Selection table

Model	DN	Installation*	Pole	Freq (Hz)	Phase	Rated Power	Curve no	Voltage	Cable	Order number**
1325S	80	X	2	60	3	[see chart]	S62, S63, S64	380	10	1325S-80X.263....380/10
1325H	100	X	4	60	3	[see chart]	S43, S44, S45	220/380/440	10	1325H-100X.46....-/10
1325M	150	X	4	60	3	[see chart]	S23, S24, S25, S26	220/380/440	10	1325M-150X.46....-/10

* X=Bare pump.

** For information on configuring the right order number, see page 7. Pumps come standard with thermal switches.

Pump Data

Model	1325S	1325H	1325M
Impeller Type	Non-clog	Non-clog	Non-clog
Outlet size (mm)	80	100	150
Weight (kg)	170	180	190
Pole	2	4	4
Insulation Class	F	F	F
Starts per hour	15	15	15
Cable	4G6 + 2x1.5	4G10 + S(2x0.5)	4G10 + S(2x0.5)

Motor Data

	1325S			1325H/M		
Voltage	380	380	380	220 380 440	220 380 440	220 380 440
Phase	3	3	3	3	3	3
Rated Power (kW)	20	15	12	15	13	10
Rated current (A)	36	27	22	53 30 26	46 27 23	37 21 19
Full Load Power Factor	0,93	0,92	0,9	0.85 0.85 0.85	0.83 0.84 0.83	0.79 0.79 0.79
Starting current (A)	231	231	231	305 174 152	305 174 152	305 174 152
Connection	D	D	D	D// Y// Dser	D// Y// Dser	D// Y// Dser

Material Data

Impeller	grey cast iron
Pump housing	grey cast iron
Stator housing	grey cast iron
Shaft	stainless steel
Inner mechanical seal	carbon/cemented carbide
Outer mechanical seal	cemented carbide/cemented carbide
O-rings	nitrile
Cable sheathing	nitrile

Process Data

Max submergence	20 m
Max fluid temp	40 °C
pH range of pumped liquid	5.5 - 14

Power Cable Data

Cable type (mm ²)	4G6 + 2x1.5 4G10 + S(2x0.5)
Outer Diameter (mm)	26 26
Weight (kg/m)	0.83 0.85

Pump dimensions (mm)

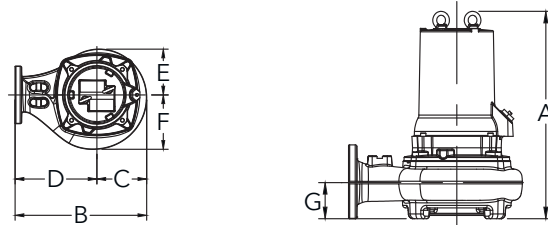

	1325S	1325H	1325M
A	650	667	663
B	505	531	550
C	175	201	220
D	330	330	330
E	175	185	187
F	175	220	259
G	82	110	137

Installation kit selection table*

DN	Free-standing	Wet well	Replacement
80	13205-80H (hose), 1325-80T (threaded)	1325-80W	1325-80R
100	1325-100H (hose), 1325-100T (threaded)	1325-100W	1325-100R
150	1325-150H (hose), 1325-150T (threaded)	1325-150W	1325-150R

* For more information, see page 6.

Right pump for your needs



Lowara 1305 Non-clog

- Maximum flow 13 l/s
- Maximum pressure 14 m
- Motor Rating 0.85 - 1.3 kW
- Outlet 50 mm
- Weight 30 kg



Lowara 1305 Vortex

- Maximum flow 10 l/s
- Maximum pressure 8 m
- Motor Rating 0.75 - 1.2 kW
- Outlet 50 mm
- Weight 30 kg



Lowara 1310 Non-clog

- Maximum flow 18 l/s
- Maximum pressure 27 m
- Motor Rating 1.8 - 2.8 kW
- Outlet 50 - 80 mm
- Weight 46 kg



Lowara 1310 Vortex

- Maximum flow 17 l/s
- Maximum pressure 19 m
- Motor Rating 1.2 - 2.8 kW
- Outlet 50 - 80 mm
- Weight 46 kg



Lowara 1315 Non-clog

- Maximum flow 55 l/s
- Maximum pressure 32 m
- Motor Rating 2.5 - 4.8 kW
- Outlet 80 - 100 mm
- Weight 95 kg



Lowara 1315 Vortex

- Maximum flow 42 l/s
- Maximum pressure 18 m
- Motor Rating 2.5 - 4.8 kW
- Outlet 80 - 100 mm
- Weight 95 kg



Lowara 1320 Non-clog

- Maximum flow 77 l/s
- Maximum pressure 46 m
- Motor Rating 3.5 - 8.2 kW
- Outlet 80 - 100 mm
- Weight 130 - 156 kg



Lowara 1320 Vortex

- Maximum flow 57 l/s
- Maximum pressure 26 m
- Motor Rating 3.5 - 8.2 kW
- Outlet 80 - 100 mm
- Weight 140 - 156 kg



Lowara 1325 Non-clog

- Maximum flow 124 l/s
- Maximum pressure 48 m
- Motor Rating 10 - 20 kW
- Outlet 80 - 150 mm
- Weight 170 - 190 kg



Xylem |'zīləm|

- 1) The tissue in plants that brings water upward from the roots;
- 2) A leading global water technology company.

We're 12,900 people unified in a common purpose: creating innovative solutions to meet our world's water needs. Developing new technologies that will improve the way water is used, conserved, and re-used in the future is central to our work. We move, treat, analyze, and return water to the environment, and we help people use water efficiently, in their homes, buildings, factories and farms. In more than 150 countries, we have strong, long-standing relationships with customers who know us for our powerful combination of leading product brands and applications expertise, backed by a legacy of innovation.

For more information on how Xylem can help you, go to www.xylem.com